

 **TUBOFLEX**  
Modular Coolant Hose System

*made in italy*  

**UGELLI IN RESINA ACETALICA**  
**MATERIALE IDONEO AL CONTATTO**  
**ALIMENTARE**



## CERTIFICAZIONI MATERIA PRIMA

### DATI TECNICI

Materiale Utilizzato: Acetalica Copolimera (POM)

Colore: Neutro ( Bianco)

### TEMPERATURE

Temperatura di Lavoro: -20° a 80°

Max. Temperatura di Utilizzo: 80°

Punto di Fusione: 165°

### CAMPI APPLICATIVI

Pneumatica & Fluidi, adatti al contatto alimentare.



#### FDA

I tubi flessibili, raccordi e ugelli Tuboflex di colore neutro (bianco) sono prodotti utilizzando materiali approvati **FDA** ( Food and Drug Administration)



#### Certificazioni NSF 51 & 61

I tubi flessibili, raccordi e ugelli Tuboflex di colore neutro (bianco) sono compatibili al contatto con Alimenti & Acqua Potabile secondo le certificazioni **NSF 51 & 61**



#### Certificazione WRAS

Il tubi flessibili, raccordi e ugelli Tuboflex di colore neutro (bianco) rispettano i requisiti **WRAS** del UK Water Regulations Advisory Scheme

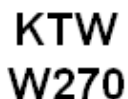

#### Certificazione KTW-W270

Il tubi flessibili, raccordi e ugelli Tuboflex di colore neutro (bianco) rispettano i requisiti **KTW-W270**

Tutti i prodotti Tuboflex sono conformi alla direttiva 2002/95/EC



Questa informativa dichiara che i materiali da noi utilizzati per la produzione della linea TUBOFLEX sono provvisti delle certificazioni sopra indicate. AWS dei f.lli Amodeo non si assume responsabilità in merito all'utilizzo finale dei suoi prodotti

### UGELLI ORIENTABILI FILETTO 1/8"



#### Informazioni Tecniche

Materiale: Acetalica Copolimera (POM)

Colore: Neutro ( Bianco)

Max. Temperatura di Lavoro :-20° a 80° C

Punto di Fusione: 165° C

Pressione: 6 bar

#### Certificazioni Materia Prima

FDA ( Food and Drinks Administration)

NSF/ANSI STANDARD 61 (Drinking Water System Components)

WRAS (Water Regulations)

UL LABORATORIES CERTIFIED

KTR - W270

### UGELLI FORO LIBERO ORIENTABILI FILETTO 1/8"

Codice	Filetto (A)	Foro (B)	C	D	H	L
18N15	1/8" NPT	ID 1,5 mm	9 mm	14 mm	41 mm	50 mm
18N30	1/8" NPT	ID 3 mm	9 mm	14 mm	41 mm	50 mm
18N50	1/8" NPT	ID 5 mm	9 mm	14 mm	41 mm	50 mm

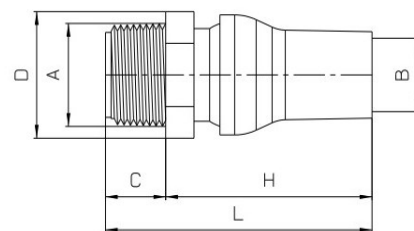

#### Informazioni Tecniche

Materiale: Acetalica Copolimera (POM)

Colore: Neutro ( Bianco)

Max. Temperatura di Lavoro :-20° a 80° C

Punto di Fusione: 165° C

Pressione: 6 bar

#### Certificazioni Materia Prima

FDA ( Food and Drinks Administration)

NSF/ANSI STANDARD 61 (Drinking Water System Components)

WRAS (Water Regulations)

UL LABORATORIES CERTIFIED

KTR - W270

### UGELLI PIATTI ORIENTABILI FILETTO 1/8"

Codice	Filetto (A)	Apertura (B)	C	D	H	L
18N25	1/8" NPT	25x2mm	9 mm	14 mm	38,5 mm	48 mm

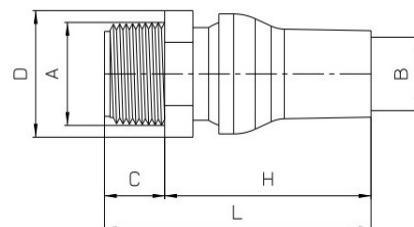

### UGELLI ORIENTABILI FILETTO 1/4"



#### Informazioni Tecniche

Materiale: Acetalica Copolimera (POM)

Colore: Neutro ( Bianco)

Max. Temperatura di Lavoro :-20° a 80° C

Punto di Fusione: 165° C

Pressione: 6 bar

#### Certificazioni Materia Prima

FDA ( Food and Drinks Administration)

NSF/ANSI STANDARD 61 (Drinking Water System Components)

WRAS (Water Regulations)

UL LABORATORIES CERTIFIED

KTW - W270

#### UGELLI FORO LIBERO ORIENTABILI FILETTO 1/4"

Codice	Filetto (A)	Foro (B)	C	D	H	L
14N15	1/4" NPT	ID 1,5 mm	9 mm	14 mm	41 mm	50 mm
14N30	1/4" NPT	ID 3 mm	9 mm	14 mm	41 mm	50 mm
14N50	1/4" NPT	ID 5 mm	9 mm	14 mm	41 mm	50 mm

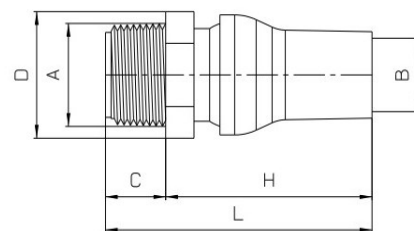

#### Informazioni Tecniche

Materiale: Acetalica Copolimera (POM)

Colore: Neutro ( Bianco)

Max. Temperatura di Lavoro :-20° a 80° C

Punto di Fusione: 165° C

Pressione: 6 bar

#### Certificazioni Materia Prima

FDA ( Food and Drinks Administration)

NSF/ANSI STANDARD 61 (Drinking Water System Components)

WRAS (Water Regulations)

UL LABORATORIES CERTIFIED

KTW - W270

#### UGELLI PIATTI ORIENTABILI FILETTO 1/4"

Codice	Filetto (A)	Apertura (B)	C	D	H	L
14N25	1/4" NPT	25x2mm	9 mm	14 mm	38,5 mm	48 mm

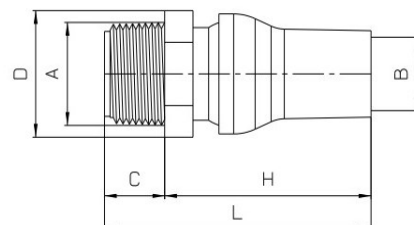

### UGELLI ORIENTABILI FILETTO 3/8"



#### Informazioni Tecniche

Materiale: Acetalica Copolimera (POM)

Colore: Neutro ( Bianco)

Max. Temperatura di Lavoro :-20° a 80° C

Punto di Fusione: 165° C

Pressione: 4 bar

#### Certificazioni Materia Prima

FDA ( Food and Drinks Administration)

NSF/ANSI STANDARD 61 (Drinking Water System Components)

WRAS (Water Regulations)

UL LABORATORIES CERTIFIED

KTW - W270

### UGELLI FORO LIBERO ORIENTABILI FILETTO 3/8"

Codice	Filetto (A)	Foro (B)	C	D	H	L
38N50	3/8" NPT	ID 5 mm	13 mm	19 mm	64 mm	76,5 mm
38N80	3/8" NPT	ID 8 mm	13 mm	19 mm	64 mm	76,5 mm
38N11	3/8" NPT	ID 11 mm	13 mm	19 mm	44,5 mm	57 mm

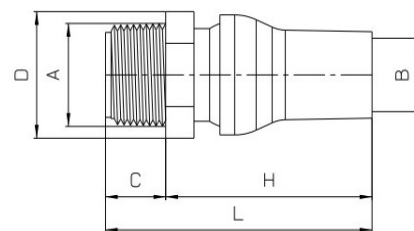

#### Informazioni Tecniche

Materiale: Acetalica Copolimera (POM)

Colore: Neutro ( Bianco)

Max. Temperatura di Lavoro :-20° a 80° C

Punto di Fusione: 165° C

Pressione: 4 bar

#### Certificazioni Materia Prima

FDA ( Food and Drinks Administration)

NSF/ANSI STANDARD 61 (Drinking Water System Components)

WRAS (Water Regulations)

UL LABORATORIES CERTIFIED

KTW - W270

### UGELLI PIATTI ORIENTABILI FILETTO 3/8"

Codice	Filetto (A)	Apertura (B)	C	D	H	L
38N52	3/8" NPT	50x2mm	13 mm	19 mm	64 mm	78 mm

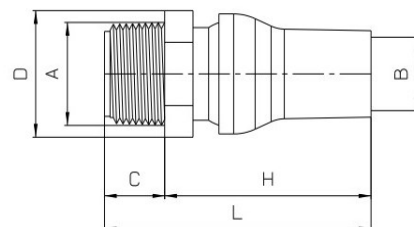

### UGELLI ORIENTABILI FILETTO 1/2"



#### Informazioni Tecniche

Materiale: Acetalica Copolimera (POM)

Colore: Neutro ( Bianco)

Max. Temperatura di Lavoro :-20° a 80° C

Punto di Fusione: 165° C

Pressione: 4 bar

#### Certificazioni Materia Prima

FDA ( Food and Drinks Administration)

NSF/ANSI STANDARD 61 (Drinking Water System Components)

WRAS (Water Regulations)

UL LABORATORIES CERTIFIED

KTW - W270

### UGELLI FORO LIBERO ORIENTABILI FILETTO 1/2"

Codice	Filetto (A)	Foro (B)	C	D	H	L
12N50	1/2" NPT	ID 5 mm	13 mm	19 mm	64 mm	76,5 mm
12N80	1/2" NPT	ID 8 mm	13 mm	19 mm	64 mm	76,5 mm
12N11	1/2" NPT	ID 11 mm	13 mm	19 mm	44,5 mm	57 mm

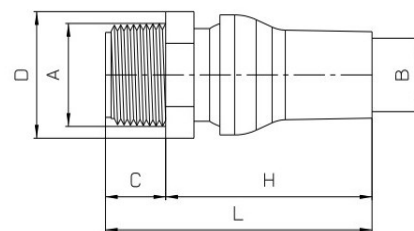

#### Informazioni Tecniche

Materiale: Acetalica Copolimera (POM)

Colore: Neutro ( Bianco)

Max. Temperatura di Lavoro :-20° a 80° C

Punto di Fusione: 165° C

Pressione: 4 bar

#### Certificazioni Materia Prima

FDA ( Food and Drinks Administration)

NSF/ANSI STANDARD 61 (Drinking Water System Components)

WRAS (Water Regulations)

UL LABORATORIES CERTIFIED

KTW - W270

### UGELLI PIATTI ORIENTABILI FILETTO 1/2"

Codice	Filetto (A)	Apertura (B)	C	D	H	L
12N52	1/2" NPT	50x2mm	13 mm	19 mm	64,5 mm	78 mm

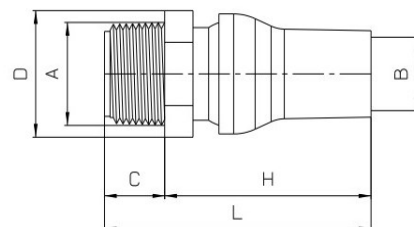



## UGELLI ORIENTABILI FILETTO 3/4"



### Informazioni Tecniche

Materiale: Acetalica Copolimera (POM)

Colore: Neutro ( Bianco)

Max. Temperatura di Lavoro :-20° a 80° C

Punto di Fusione: 165° C

Pressione: 2 bar

### Certificazioni Materia Prima

FDA ( Food and Drinks Administration)

NSF/ANSI STANDARD 61 (Drinking Water System Components)

WRAS (Water Regulations)

UL LABORATORIES CERTIFIED

KTW - W270

### UGELLI FORO LIBERO ORIENTABILI FILETTO 3/4"

Codice	Filetto (A)	Foro (B)	C	D	H	L
34N16	3/4" NPT	ID 16 mm	16 mm	28 mm	58 mm	75 mm
34N19	3/4" NPT	ID 19 mm	16 mm	28 mm	58 mm	75 mm

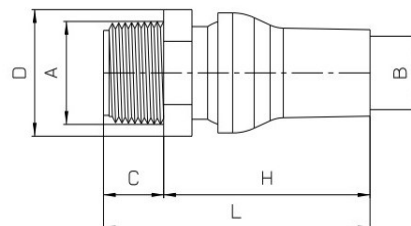

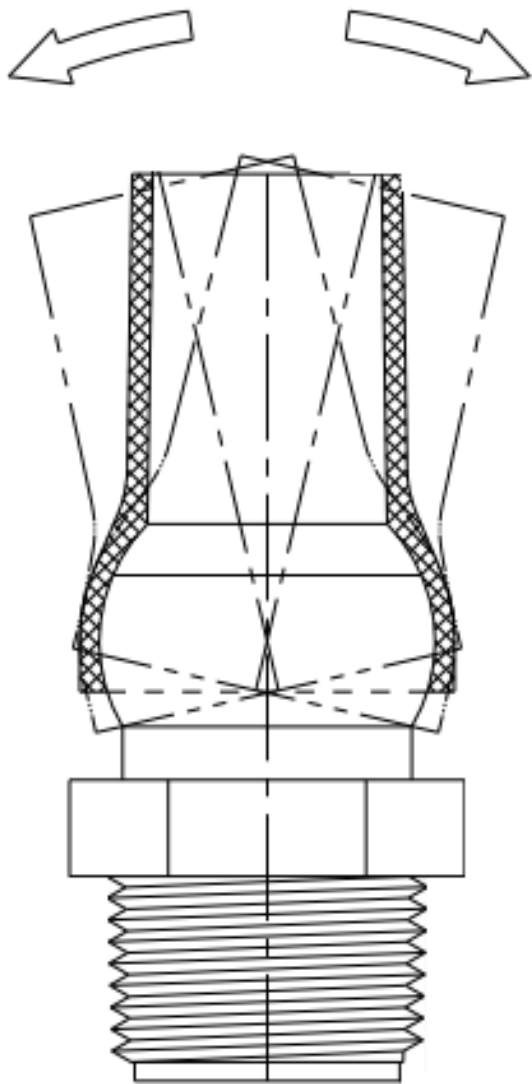

# TUBOFLEX

Modular Coolant Hose System

TUBOFLEX è un marchio di

AWS dei F.lli Amodeo Snc  
Via Walter Tobagi n.5  
20081 - Abbiategrasso (MI) Italia

Tel. +39.02.9422253 Fax. + 39.02.94240059

Web site : [www.tuboflex.it](http://www.tuboflex.it) E-mail: [sales@tuboflex.it](mailto:sales@tuboflex.it)

DISTRIBUITO DA: